

Shelly Plus Line **Everything...** **PLUS more!**

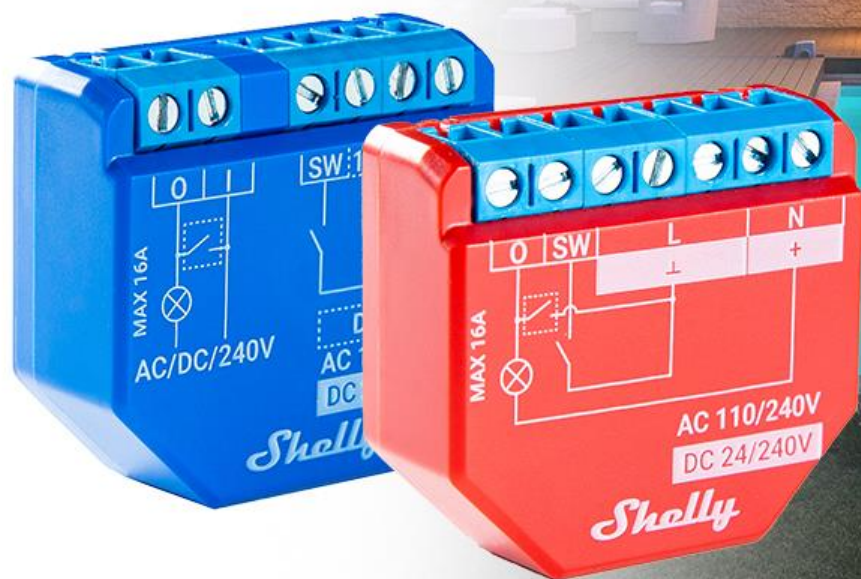

Shelly

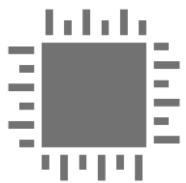

Extremely fast processor



Bluetooth connectivity



Enhanced safety

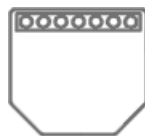

Improved and unified shell



Improved integration

Next Generation Shelly devices

Enjoy supreme home automation and control with the new generation Shelly devices - Shelly Plus!

Shelly smart relays now come with perfected electrical appliances control through an extremely fast processor, quicker connectivity, improved integration, and enhanced safety! You can now add devices easily via Bluetooth connection, using Shelly Cloud App. Shelly Plus line supports TLS encryption and has improved shell for standardized support for external sensor plugs.

New & Improved shell

Shelly Plus line comes in a **unified and improved shell**. Thanks to Plus line devices' small dimensions, they easily fit behind any wall switch or wall socket. Each Plus line device comes with a **wiring diagram** printed on its shell to ensure safe and easy installation.

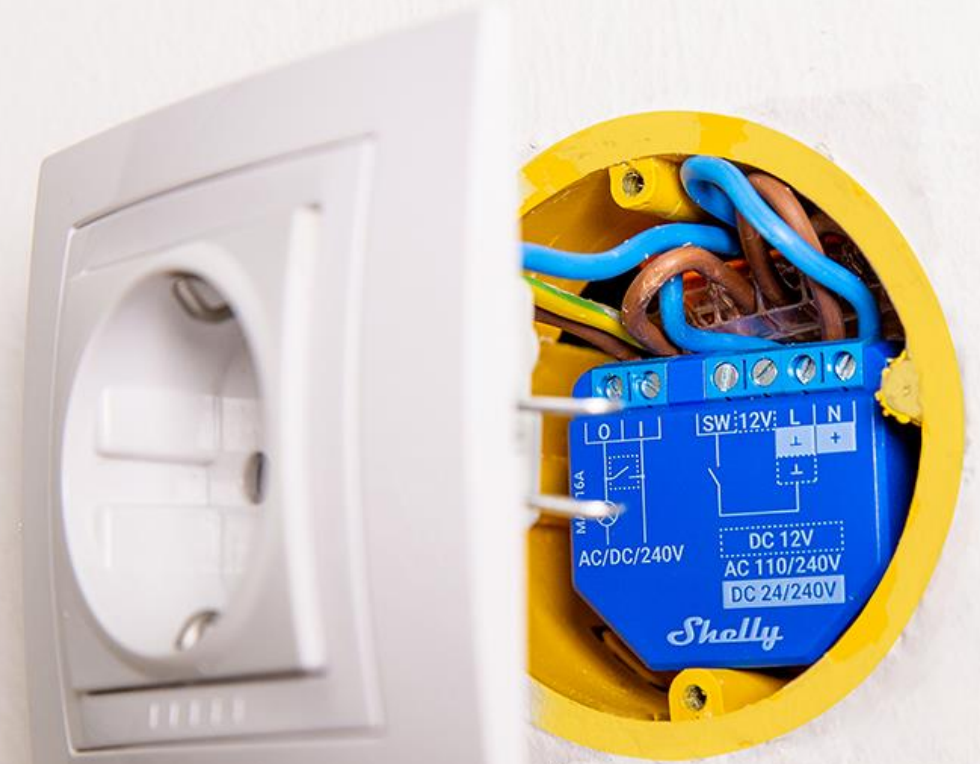
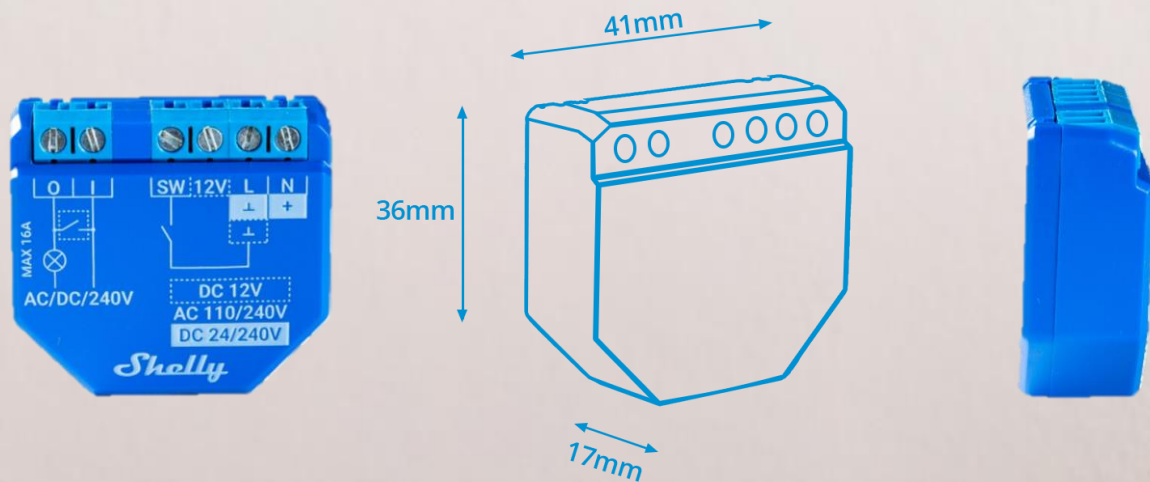

Improved integration

Create the smart home of your dreams even easier with Shelly Plus line thanks to an improved API interface and standardized RPC allowing a broad range of cloud-connected and local integrations for a much lower cost for implementation!



Improved **API** interface



Standardized **RPC**



Lower implementation **cost**

 Overtemperature **protection** Failures **prevention** **MQTT** and **WSS** support

Enhanced Safety & Security



Safety is our top priority! Shelly Plus line has a temperature sensing software thresholds for control and prevention of failures. Firmware now supports more encryption modes and secure storage.

Smart Features

HTTP/HTTPS WEBHOOKS FOR QUICK CONNECTION

Enhanced with HTTP/HTTPS webhooks, Shelly Plus line can easily connect with, notify or control another compatible equipment or 3rd party automation system.

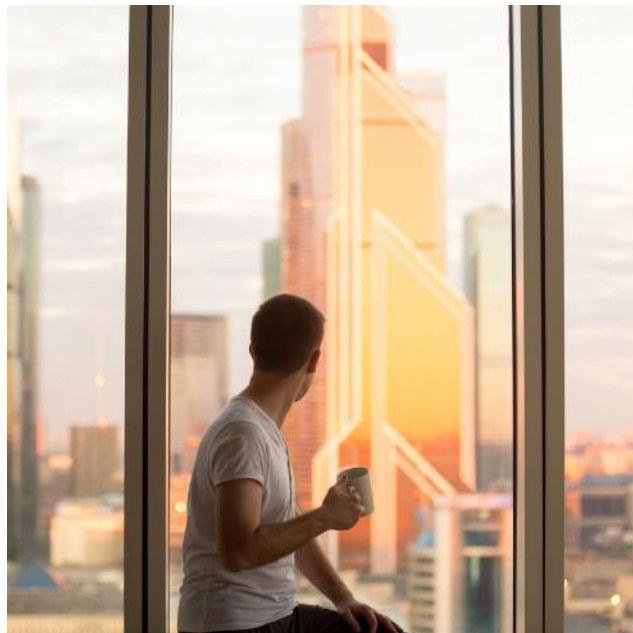
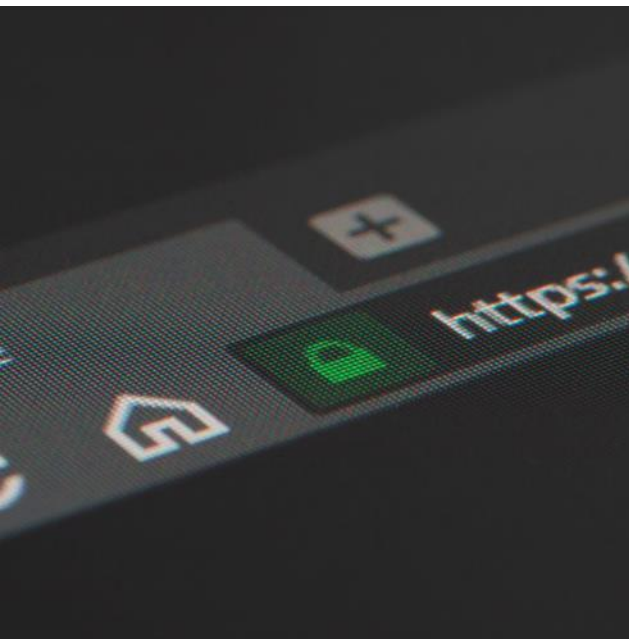

SMART ACTIONS FOLLOWING THE SUNRISE/SUNSET

Shelly Plus line can switch on/off the power, depending on the Sunset or Sunrise hour, which makes it perfect for dynamic control of the electrical equipment.

CUSTOM AUTOMATION WITH WEEKLY SCHEDULING

Shelly Plus line allows you to set up to 50 actions based on your daily or weekly schedule with no need for an external hub or server.

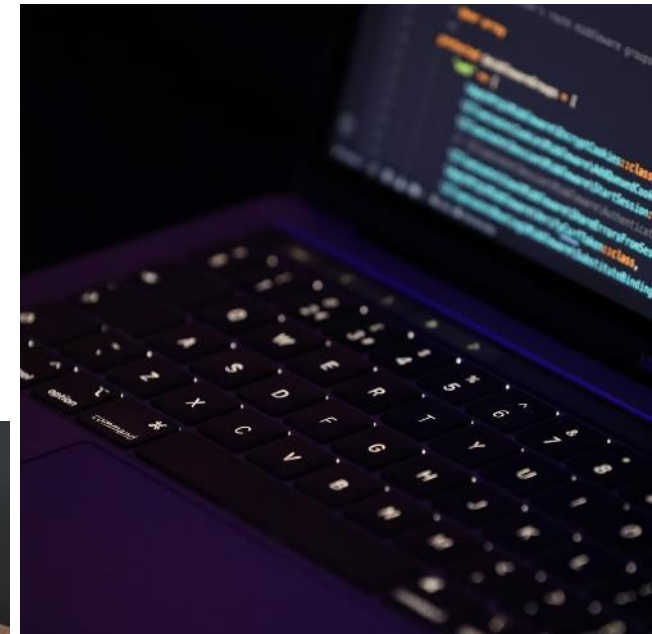

SCRIPTING FOR CUSTOM AUTOMATION

Shelly Plus line fully supports mJS scripting, allowing customers to create own features and functionalities! Additionally, multiple scripts can be executed together.



Shelly Plus 1

Home automation experience
and enhanced lighting control,
perfected!



Shelly Plus 1

Home automation experience and enhanced lighting control, perfected.



Wi-Fi operated



Bluetooth



Dry Contacts



Low voltage support



Overtemperature protection

Automatization of the lights, the garage door, the irrigation system, the bathroom fan, any old electrical appliances... you name it! Shelly Plus 1 has numerous applications providing enhanced smart home control.

Small enough to fit behind every wall switch or wall socket, Shelly 1 can be installed in less than 10 minutes. Thanks to the Bluetooth inclusion, you can now add and set up Shelly 1 to your home automation system even faster!

1 device. Endless possibilities.

AUTOMATE THE LIGHTS AND MAKE THEM FOLLOW YOUR SCHEDULE

Make any light switch smart with Shelly Plus 1 and control them through your phone or with a voice assistant. Use Shelly App to set automated scenes based on an hour or the sunset/sunrise.

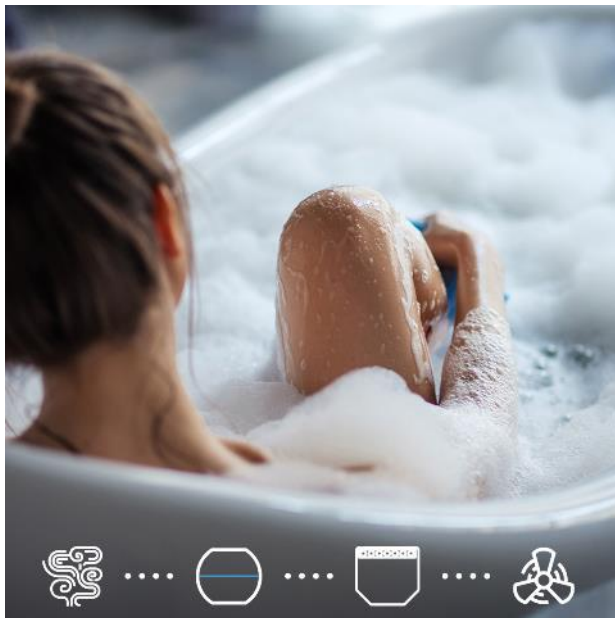

SET SMART SCENES AND BE PREPARED FOR ANYTHING

Reveal the full potential of Shelly Plus 1 by combining it with other devices from your home network! Set Shelly Plus 1 to activate custom scenes based on hour, light, or various occurrences.

EASILY CONTROL THE GARAGE DOOR AT HOME NO MATTER WHERE YOU ARE

Easily automate your garage door and control it no matter where you are! Shelly Plus 1 has operational voltages of 12V and 240V DC which makes it perfect for garage door control.

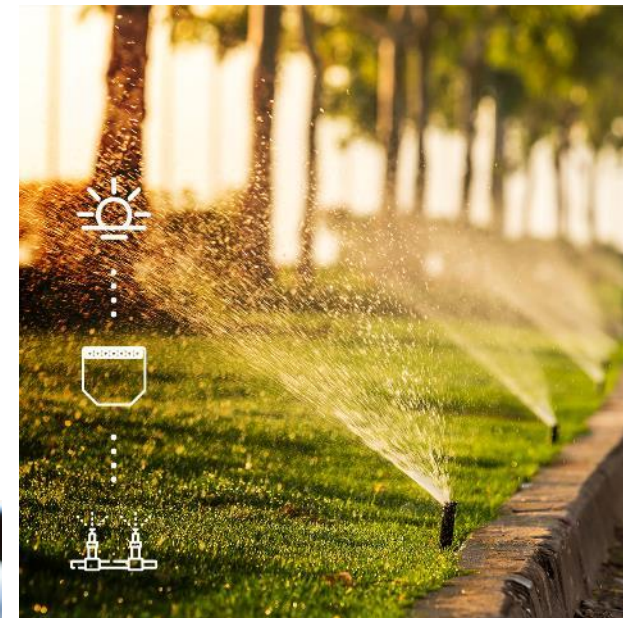

AUTOMATE YOUR IRRIGATION SYSTEM BASED ON SUNRISE/SUNSET HOURS

Use Shelly Plus 1 to automate your irrigation system to follow the sun and water your garden right before sunrise and after sunset to prevent your plants and grass from drying.



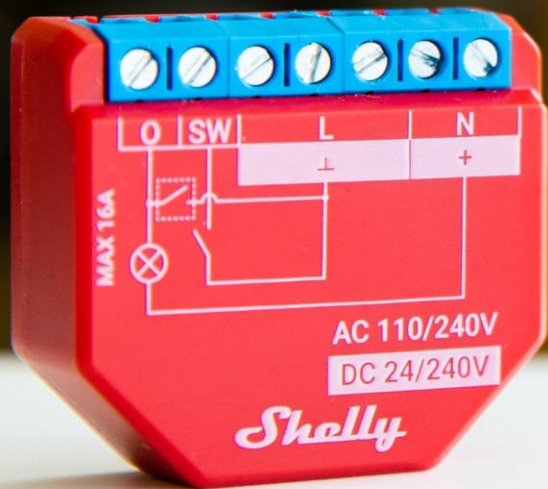

Shelly Plus 1PM

Enhanced electrical appliances control with precise power metering

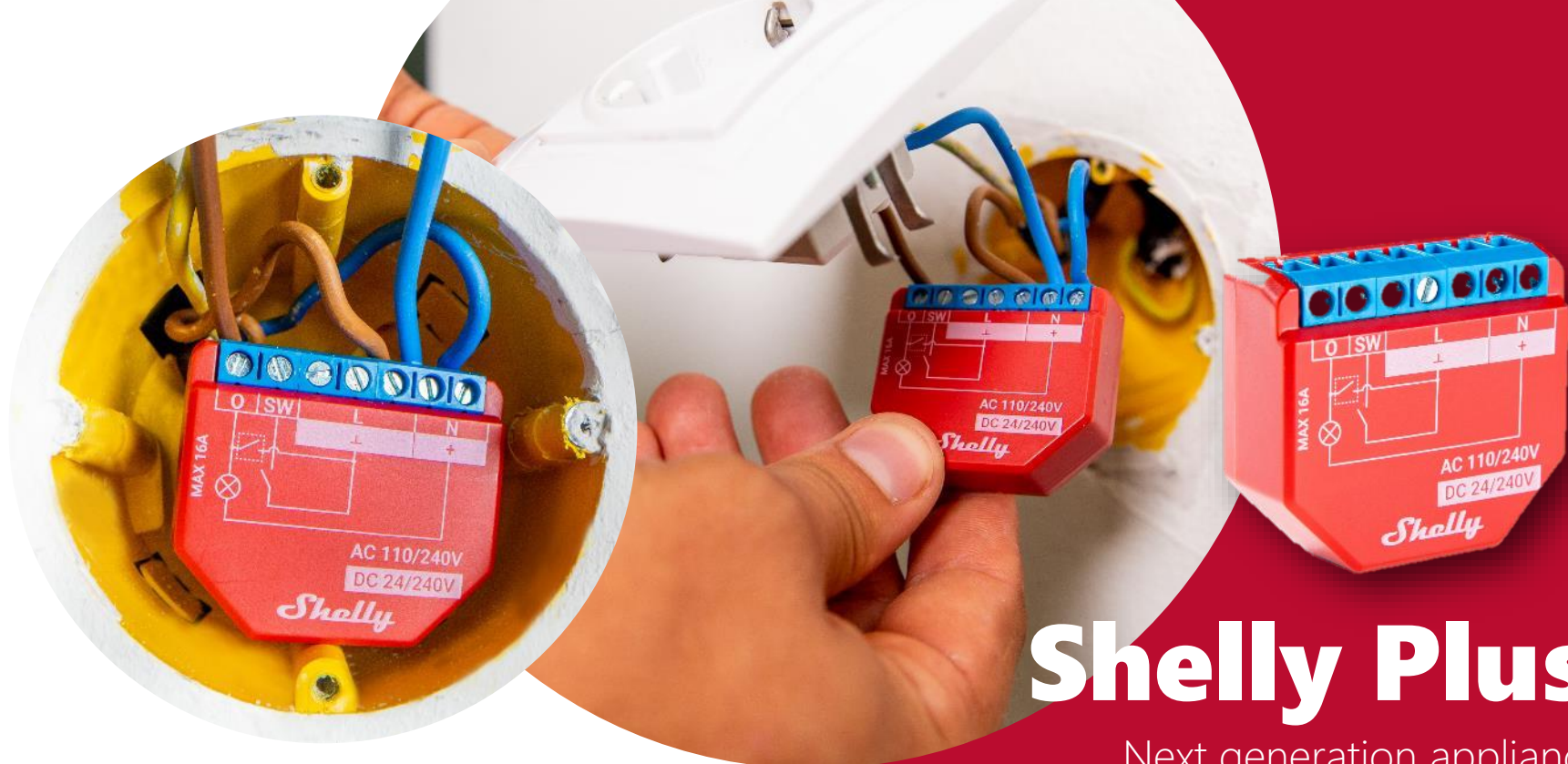

Shelly Plus 1PM

Next generation appliances control with precise power metering.



Wi-Fi operated



Bluetooth



Power metering



Overpower and overvoltage protection



Overtemperature protection

From automatization of the lights to electrical appliances control, Shelly Plus 1PM provides precise power metering and free cloud data storage.

Small enough to fit behind every wall switch or wall socket, Shelly 1PM can be installed in less than 10 minutes. Thanks to the Bluetooth inclusion, you can now add and set up Shelly 1PM to your home automation system even faster!

1 device. Endless possibilities.

TRACK YOUR POWER CONSUMPTION AND SAVE MONEY

Monitor the power consumption of your electrical appliances to save money on electricity bills thanks to Shelly 1PM's over 1 year free power consumption data storage and two integrated precise power meters.



AUTOMATE ANY ELECTRICAL APPLIANCE AND CONTROL IT REMOTELY

With Shelly Plus 1PM you can automate any electrical appliance in your home and control it remotely. You can get precise measurement of the power consumption of each appliance and switch in off remotely.

COME HOME TO A COZY HOUSE

Set Shelly 1PM to turn on the heating appliances in your house an hour before you come from work. Remotely monitor the power consumption of your heaters to make sure they're running and warming up and always come home to a cozy house in the cold winter days.

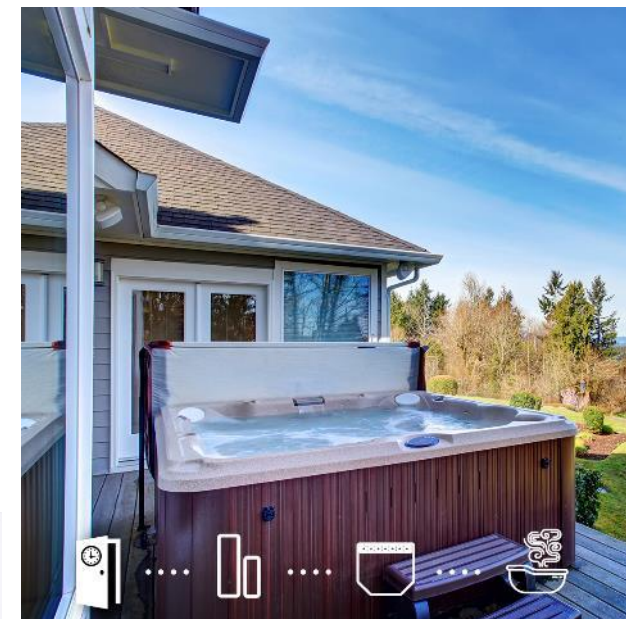

SET SMART SCENES AND BE PREPARED FOR EVERYTHING

Reveal the full potential of Shelly Plus 1PM by combining it with other devices from your home network! Set Shelly Plus 1PM to activate custom scenes based on hour, light, or various occurrences.

Highly compatible!

Use your preferred **voice assistant** to control Shelly Plus line of devices!



Alexa, turn on the lights!

Sure! Turning on the lights.

No hub required!

Shelly Plus Line devices can be controlled directly and without a hub through your smartphone with **Shelly Cloud App**.

Get Shelly App from:

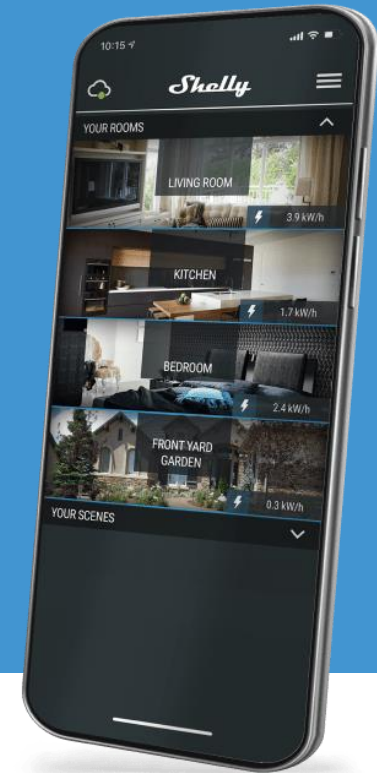

Google HOME



nymea



Supported platforms

Use devices with your one local or centralized server, you can keep them to fully isolated from public Internet network.

Shelly Plus line is fully compatible with Amazon Alexa, Home Assistant, Smart Things and other 3rd party home automation platforms.

Shelly

Make IoT Simple!